

**Titanised mesh implants
for reconstructive and
plastic breast surgery**

TiLOOP® Bra Pocket

TiLOOP® Bra

TiLOOP® Bra MPX

www.pfmmedical.com

NEW



General Benefits

Complete portfolio

The TiLOOP® Bra product family covers all indications for breast surgery with tissue reinforcing material.

TiLOOP® Bra Pocket ▶ Pre-pectoral reconstruction/augmentation

TiLOOP® Bra ▶ Sub-pectoral reconstruction/augmentation

TiLOOP® Bra MPX ▶ Mastopexy/reduction surgery/symmetrical alignment

Extra light and soft

The TiLOOP® Bra extralight (16 g/m²) introduces the least amount of foreign material into the breast. The light weight material facilitates optimal tissue adaptation, which is of particular importance for the application in the sensitive breast area.

0 g/m ²	TiLOOP® Bra extralight 16 g/m ²	TiLOOP® Bra light 35 g/m ²	100 g/m ²
		SERAGYN® BR 28 g/m ² after resorption*	TiO ₂ Mesh™ BRA** 47 g/m ²
			SERAGYN® BR 85 g/m ² before resorption*

Surface weight comparison of synthetic meshes that are approved for breast surgery in Europe.

Optimal capsule quality

Compared to simple polypropylene, the hydrophilic and titanised surface carries a reduced risk of inflammation¹ and thus a reduced tendency towards the formation of connective tissue-like scars and shrinkage: combined with minimal weight and large pores (1.0 mm), this provides the ideal conditions for a permanent, stable result as well as both desirable tissue ingrowth and a vascularised, flexible, and therefore optimum capsule quality.

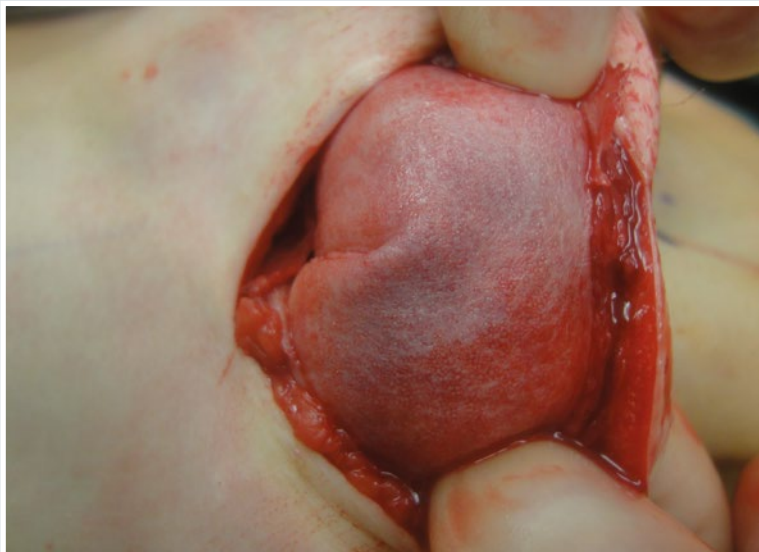

Optimal ingrowth

TiLOOP® Bra extralight 3 years after implantation
(courtesy of Dr. Stefan Paepke, Munich)

* Brochure SERAGYN® BR, Item No 801026 March 2015

** Brochure TiO₂Mesh™ BRA, MDD104.02/2015-05

General Details

- ▶ **Titanised Type 1a polypropylene mesh**
- ▶ **Weight:** 16 or 35 g/m²
- ▶ **Pore size:** 1.0 mm
- ▶ **Monofilament fabric**
- ▶ **Non-resorbable**
- ▶ **Atraumatic, laser-cut edges**
- ▶ **EO-sterilised (ethylene oxide), pyrogen free**

Knowledge

One of the determining factors for successful breast surgery in the long term, is the correct decision for or against the use of tissue reinforcing material (synthetic mesh or ADM).

TiLOOP® Bra mesh implants* are made of Type 1a polypropylene mesh (macroporous, light & monofilament) with a titanised, hydrophilic surface. Compared to simple polypropylene, this offers a number of advantages, which are already known in the use of titanised mesh implants for hernia surgery, such as:

- ▶ better cell growth²
- ▶ lower risk of inflammation¹
- ▶ less scarring³
- ▶ less shrinkage of the mesh¹

Increased cell vitality through titanisation

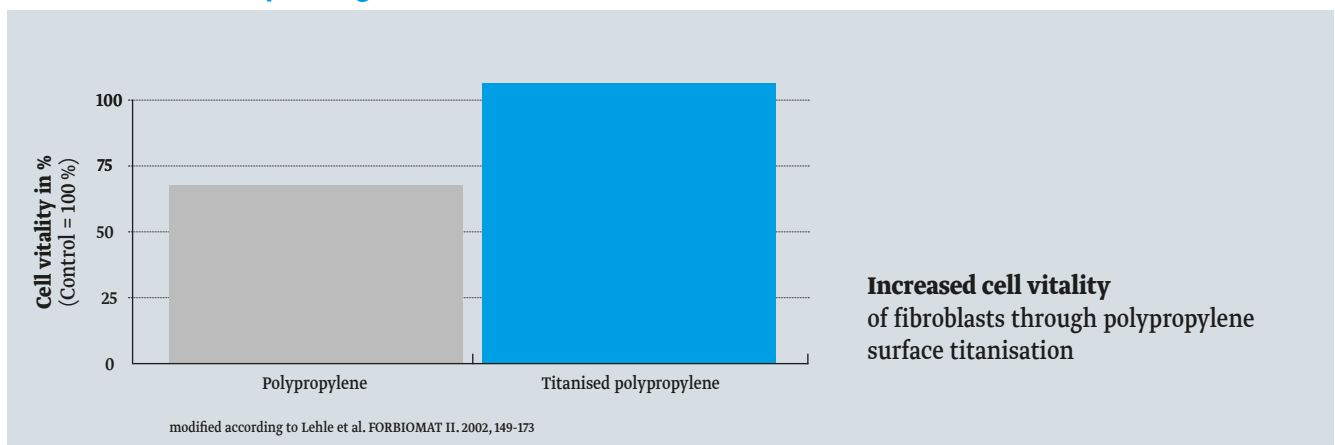

* TiLOOP® Bra mesh implants are not a tissue replacement.

TiLOOP® Bra Pocket

View



Benefits

Muscle-preserving, pre-pectoral

The pre-pectoral placement of the implant eliminates the need to detach the muscle from the chest wall and therefore less postoperative pain. The result is a shorter recovery time and the preservation of muscle function. Your patients are less affected in their daily lives.

Excellent aesthetic results

The pre-pectoral placement enables the breast implant to assume the physiological position of the subcutaneous breast tissue, resulting in excellent aesthetics and a natural-looking ptosis.^{4,5,6}

Excellent quality of life

The pre-pectoral reconstruction and the associated benefits improve the patients' quality of life.^{5,6}

Shorter surgery

TiLOOP® Bra Pocket is a ready-to-use implant. No lengthy fitting procedure, e.g., via intraoperative sutures or hydration, is required. The pre-pectoral reconstruction takes less time than the sub-pectoral reconstruction, since there is no need to prepare the pectoralis major. The patient is therefore anaesthetised for a shorter period.

Protected implant

TiLOOP® Bra Pocket is an implant pocket, which fixes the freely selectable breast implant on the muscle and thus prevents dislocation or twisting. Studies have provided evidence of a low capsule contracture rate, while maintaining an excellent capsule quality.^{5,6}

Stretch-optimised implant

The stretch properties of TiLOOP® Bra Pocket have been developed to meet the physiological demands of natural shoulder movements and ptosis.

Range of Application

TiLOOP® Bra Pocket can be used in any breast surgery, where the pre-pectoral use of tissue-supporting, reinforcing and bridging materials is indicated.

- ▶ **Reconstructive breast surgery:** implant-based reconstruction (also with expander), e.g., after a skin-sparing or nipple-sparing mastectomy.
- ▶ **Plastic-aesthetic breast surgery:** primary or corrective augmentations

Application

Recommended Implantation Procedure

TiLOOP® Bra Pocket is either fixed on the fascia of the pectoralis major, or directly on the pectoralis major. The implant front, facing the skin, should be completely covered with mesh material. TiLOOP® Bra Pocket undergoes pre-pectoral fixation with cranial, medial and lateral attachment, in order to prevent dislocation of the mesh and implant.

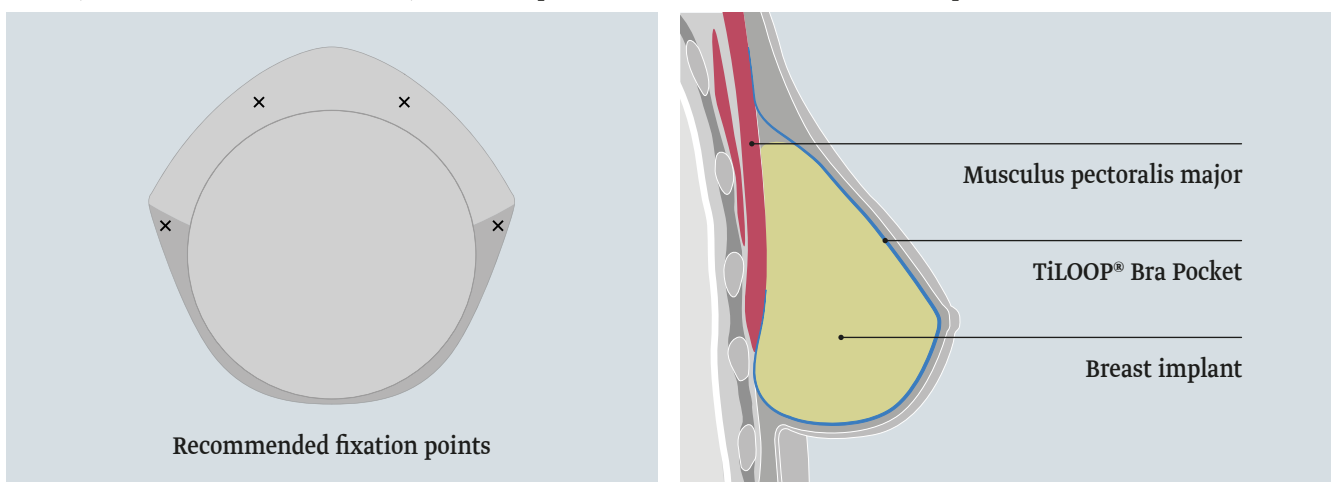

Ordering Information

TiLOOP® Bra Pocket ▶ orientation assistance for the selection of the correct mesh size

Size	Width of the implant	Projection height of the implant	Volume of the implant	Weight	REF	PU
small	< 11.0 cm	< 4.5 cm	< 270 ml	16 g/m ²	6001383	1
medium	< 13.0 cm	< 5.5 cm	< 420 ml	16 g/m ²	6001385	1
large	< 15.0 cm	< 6.0 cm	< 550 ml	16 g/m ²	6001387	1

TiLOOP® Bra

View

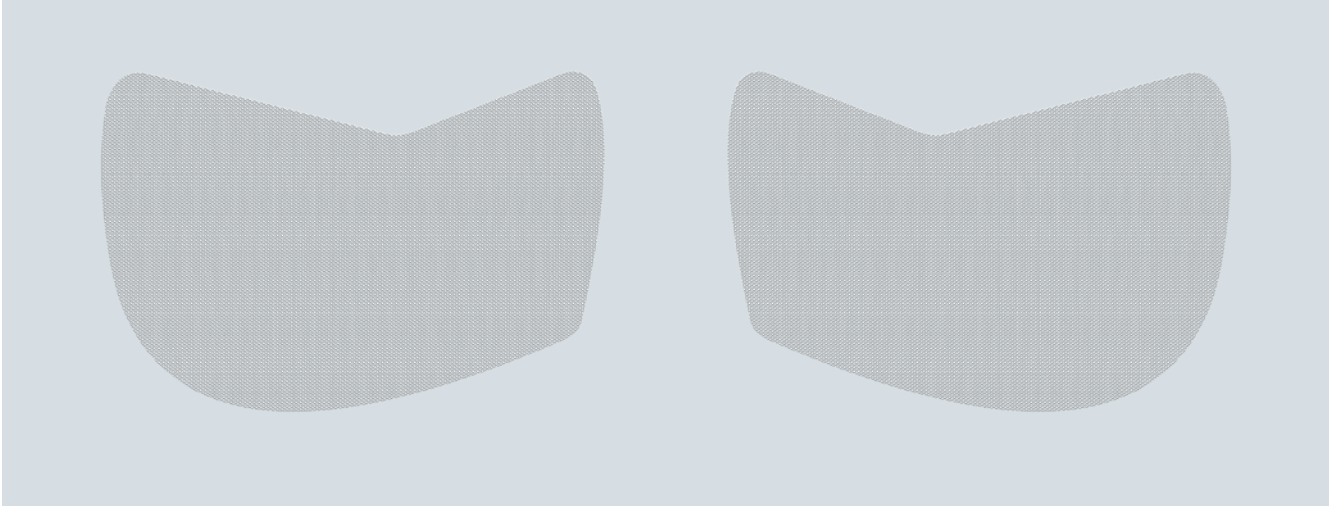

Benefits

Excellent trial history: proved quality

TiLOOP® Bra has been used in breast surgery since 2008. It has been subjected to numerous trials.

A selection:

► Reconstructions: 48

Description: TiLOOP® Bra vs. ADM in immediate implant-based breast reconstruction, prospective, randomised

Results: good cosmetic outcomes, high level of patient satisfaction and less implant loss with the TiLOOP® Bra

Authors: Gschwantler-Kaulich et al., 2016

► Reconstructions: 272

Description: TiLOOP® Bra vs. corial flaps, in immediate implant-based breast reconstruction, prospective

Results: better cosmetic results and less implant loss with TiLOOP® Bra

Authors: Rezai et al., 2015

► Reconstructions: 231

Description: TiLOOP® Bra in implant-based breast reconstruction, retrospective

Results: TiLOOP® Bra is safe, and suitable for implant-based breast reconstruction

Authors: Dieterich et al., 2013

Versatile

TiLOOP® Bra can be used for both primary and secondary breast reconstruction. Further, the use of an expander is also an option.

Range of Application

TiLOOP® Bra serves to support, strengthen and bridge the body's own tissue structures, as part of reconstructive and plastic-aesthetic breast surgery.

- Primary breast reconstruction, e.g., after a skin-sparing or nipple-sparing mastectomy
- Secondary breast reconstruction
- Replacement of breast implant

Application

TiLOOP® Bra is intended for extension of the pectoralis major, in case of sub-pectoral, implant-based (permanent implant or expander) breast reconstruction. TiLOOP® Bra covers and fixes the caudal pole of the breast implant. The pectoralis major is protected from cranial movement.

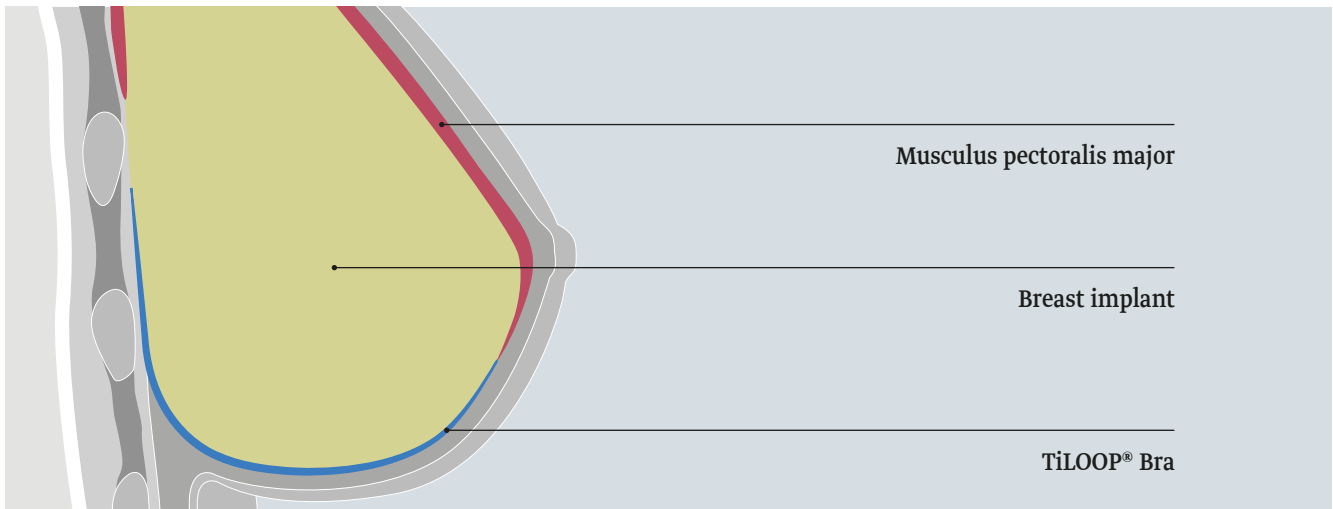

Dimensions

TiLOOP® Bra

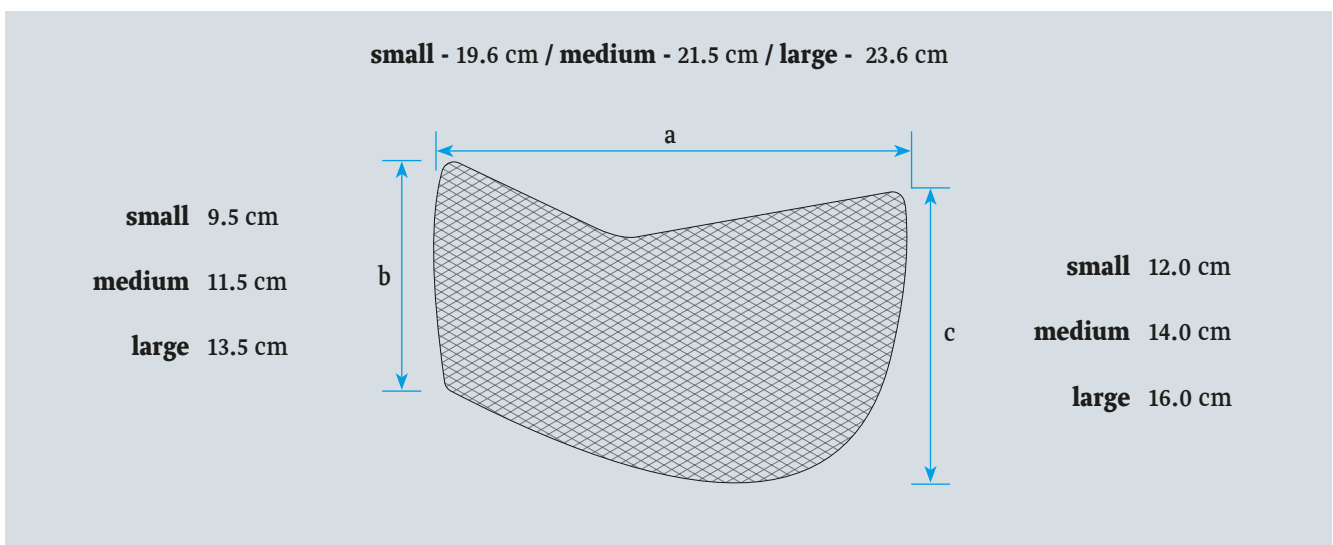

Ordering Information

TiLOOP® Bra

Size	Weight	REF	PU
small	16 g/m ²	6000636	1
	35 g/m ²	6000639	1
medium	16 g/m ²	6000637	1
	35 g/m ²	6000640	1
large	16 g/m ²	6000638	1
	35 g/m ²	6000641	1

Literature

1. Scheidbach et al. In vivo studies comparing the biocompatibility of various polypropylene meshes and their handling properties during endoscopic total extraperitoneal (TEP) patchplasty. *Surg Endosc* (2004) 18: 211-220
2. Lehle K., Lohn S. Verbesserung des Langzeitverhaltens von Implantaten und anderen Biomaterialien auf Kunststoffbasis durch plasmaaktivierte Gasphasenabscheidung (PACVD), Abschlussbericht Forschungsverbund "Biomaterialien (FORBIOMAT II)", 149-173, 2002
3. Scheidbach et al. Influence of Titanium Coating on the Biocompatibility of a Heavyweight Polypropylene Mesh. *Eur Surg Res* (2004) 36: 313-317
4. Casella et al. TiLoop® Bra mesh used for immediate breast reconstruction: comparison of retropectoral and subcutaneous implant placement in a prospective single-institution series. *Eur J Plast Surg* (2014) 37 (11): 599-604
5. Bernini et al. Subcutaneous Direct-to-Implant Breast Reconstruction: Surgical, Functional, and Aesthetic Results after Long-Term Follow-Up. *Plast Reconstr Surg Glob Open* (2016) 3 (12):e574
6. Casella et al. Subcutaneous Tissue Expander Placement with Synthetic Titanium-Coated Mesh in Breast Reconstruction: Long-term Results. *Plast Reconstr Surg Glob Open* (2016) 3 (12):e577
7. Gschwantler-Kaulich et al. Mesh versus acellular dermal matrix in immediate implant based breast reconstruction - A prospective randomized trial. *EJSO* (2016) 42(5): 665-671
8. Rezaei et al. Risk-reducing, conservative mastectomy - analysis of surgical outcome and quality of life in 272 implant-based reconstructions using TiLoop® Bra versus autologous corial flaps. *Gland Surgery* (2015) 5(1): 1-8
9. Dieterich et al. Implant-based breast reconstruction using a titanium-coated polypropylene mesh (TiLOOP Bra): a multicenter study of 231 cases. *Plast Reconstr Surg* (2013) 132(1): 8e-19e

Videos

www.pfmmedical.com/meshvideos



Workshops

www.pfmmedical.com/meshworkshops



Contact

Should you have any questions our Customer Solutions Team will be glad to assist you.

 service@pfmmedical.com

 +49 (0)2236 9641-220

 +49 (0)2236 9641-50

pfm medical ag
Wankelstraße 60
50996 Köln, Germany

Certified according to
DIN EN ISO 13485

Manufacturer
pfm medical titanium gmbh, Südwestpark 42, 90449 Nürnberg, Germany,  0124

